

455 Balanced Regulator

Contents

455BAL-1	1.1 General	455BAL-11	1.4.4 Main Tube Components Disassembly
455BAL-1	1.2 455 Balanced Regulator Performance	455BAL-13	1.4.5 Regulator Body and Exhaust Disassembly
455BAL-1	1.2.1 Test for Correct Adjustment	455BAL-14	1.5 455 Balanced Regulator Reassembly
455BAL-2	1.2.1.1 Purge Test	455BAL-14	1.5.1 Regulator Body and Exhaust Reassembly
455BAL-2	1.2.1.2 Lever Play	455BAL-16	1.5.2 Flex Knob Reassembly
455BAL-3	1.2.2 Adjusting the 455 Balanced Regulator	455BAL-19	1.5.3 Main Tube Components Reassembly
455BAL-4	1.3 455 Balanced Regulator Removal from Helmet or BandMask	455BAL-22	1.5.4 Installing the Main Tube into the Regulator Body
455BAL-6	1.4 455 Balanced Regulator Disassembly	455BAL-25	1.5.5 Regulator Cover Retainer Assembly Reassembly
455BAL-6	1.4.1 Regulator Cover Retainer Assembly Disassembly	455BAL-27	1.6 Installing the 455 Balanced Regulator onto the Helmet or BandMask
455BAL-7	1.4.2 Main Tube Disassembly		
455BAL-9	1.4.3 Flex Knob Disassembly		

1.1 General



VIDEO



Kirby Morgan 455
Balanced Regulator

<https://www.youtube.com/watch?v=niLRuNUNmTw>

The 455 Balanced Regulator is an ultra-high performance regulator, continuing the long line of exceptional regulators from Kirby Morgan®. Its construction and materials make it an extremely rugged regulator.



NOTE

When storing the helmet for any length of time, ensure that the flex knob, for adjusting the regulator, is turned “out” fully counterclockwise to avoid stressing the bias spring. This will prolong the life of both the inlet valve, seat, and bias spring.

1.2 455 Balanced Regulator Performance

The 455 Balanced Regulator is an all stainless steel regulator of a balanced design that offers far greater overall breathing performance than the non-balanced SuperFlow® and SuperFlow® 350 regulator.

1.2.1 Test for Correct Adjustment

Tools required:

- Regulated air supply, 135 to 150 psig through Standard Scuba Second Stage Hose

To maintain optimum performance of the demand regulator, it should be checked for proper function and adjustment prior to commencement of diving each diving day, in accordance with the KMDSI Daily Set Up and Functional Checklist. See the Kirby Morgan® or Dive Lab websites for

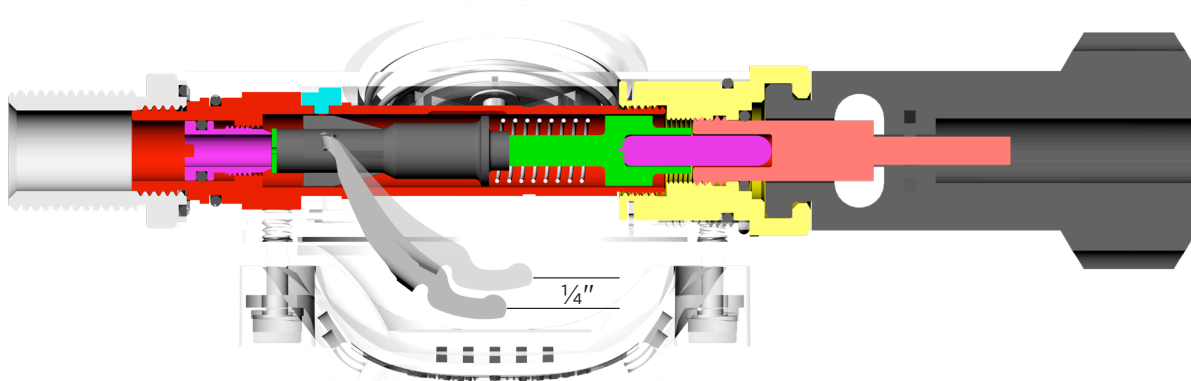

Diagram of maximum lever arm travel.

the latest checklists at www.kirbymorgan.com or www.divelab.com.

Check the regulator for adjustment and proper function with the assembly complete, and attached to a regulated gas supply (normally the EGS system), adjusted to between 135–150 psig. This can be done with the bent tube in place or with the bent tube and bent tube adapter removed and gas supplied through a standard SCUBA hose.

Checking for proper adjustment of the 455 balanced regulator must be done with the L.P. gas attached and turned on.



135 to 150 psig over ambient is the standard supply pressure to be used when adjusting the 455 Balanced regulator.

1.2.1.1 Purge Test

1) Rotate the flex knob in, clockwise towards the regulator body, until a clicking can be heard with each full turn of the knob.



This is an audible indication the tension of the bias adjustment spring is as tight as it will get. The adjustment knob will never bottom out or stop turning in this direction and no damage to the mechanism will occur. The adjustment knob should only stop turning when it is turned all the way out (counter clockwise away from the regulator body).

2) Attach an L.P. regulated gas supply to regulator inlet or helmet side block.

3) Turn on gas supply slowly.

4) Rotate the Flex Knob out counterclockwise slowly, three full turns.

5) Lightly depress the regulator purge cover several times and ensure the gas flow is stable.



The regulator may free flow when purged if there is no backpressure (resistance) in the oral nasal, (e.g. the diver's face is not correctly positioned into the oral nasal mask). If the regulator free flows, simply covering the air outlet tube of the regulator inside the helmet or BandMask® should stop any free flow.

6) Push in gently on the cover of the regulator. There should be 1/4" free travel in the cover before gas flow starts. When the cover is fully depressed, a strong surge of gas must be heard.

7) If the purge cover has NO play, or play is greater than 1/4" BEFORE GAS flow is heard, the demand regulator requires internal adjustment, per "1.2.2 Adjusting the 455 Balanced Regulator" on page 455BAL-3.

1.2.1.2 Lever Play

1) Turn the adjustment knob all the way in, clockwise toward the regulator.

2) Remove the regulator cover retainer assembly and diaphragm.

3) Attach an L.P. supply to the regulator inlet or helmet side block.

4) Slowly turn on the gas supply.

5) Rotate the flex knob out (counterclockwise) three full turns.

6) Check lever arm play, there should be about ¼ inch of free play in the lever and no gas flow.

7) Depress the lever arm several times, ensure a good flow and confirm the lever play does not change.

If the lever play is outside the recommended parameters or if there is no strong gas flow when the lever arm is depressed the regulator will require adjustment.

1.2.2 Adjusting the 455 Balanced Regulator

Tools required:

- Regulated air supply, 135 to 150 psig through standard SCUBA Second Stage Hose
- ¼ inch Flat Blade Screwdriver
- 11/16 inch Open End Wrench

- 7/8 (2) inch Open End Wrench



NOTE

The quickest and easiest way to supply gas to the regulator for testing in between adjustments is to use a standard first stage scuba regulator with an open ended standard second stage supply hose. The female fitting will thread onto the inlet tube in place of the bent tube adapter.

It is not necessary to remove the regulator from the helmet to perform field maintenance, however, for scheduled overhauls the regulator should be completely removed from the helmet and disassembled. The design of this regulator also allows the technician to remove the main tube as a complete unit for service or as a rapid replacement in the field.



NOTE

If there is **too much play** in the lever, the adjustable nipple will need to be **turned out (counterclockwise)**. **Too little play**, the nipple will need to be **turned in (clockwise)**. If the purge cover can be pushed in further than ¼" the nipple will need to be turned out slightly.

Whatever direction is needed, make the adjust-

NOTE: two LP plugs for manufacturer's test purposes only. Do not remove unless O-rings require replacement.

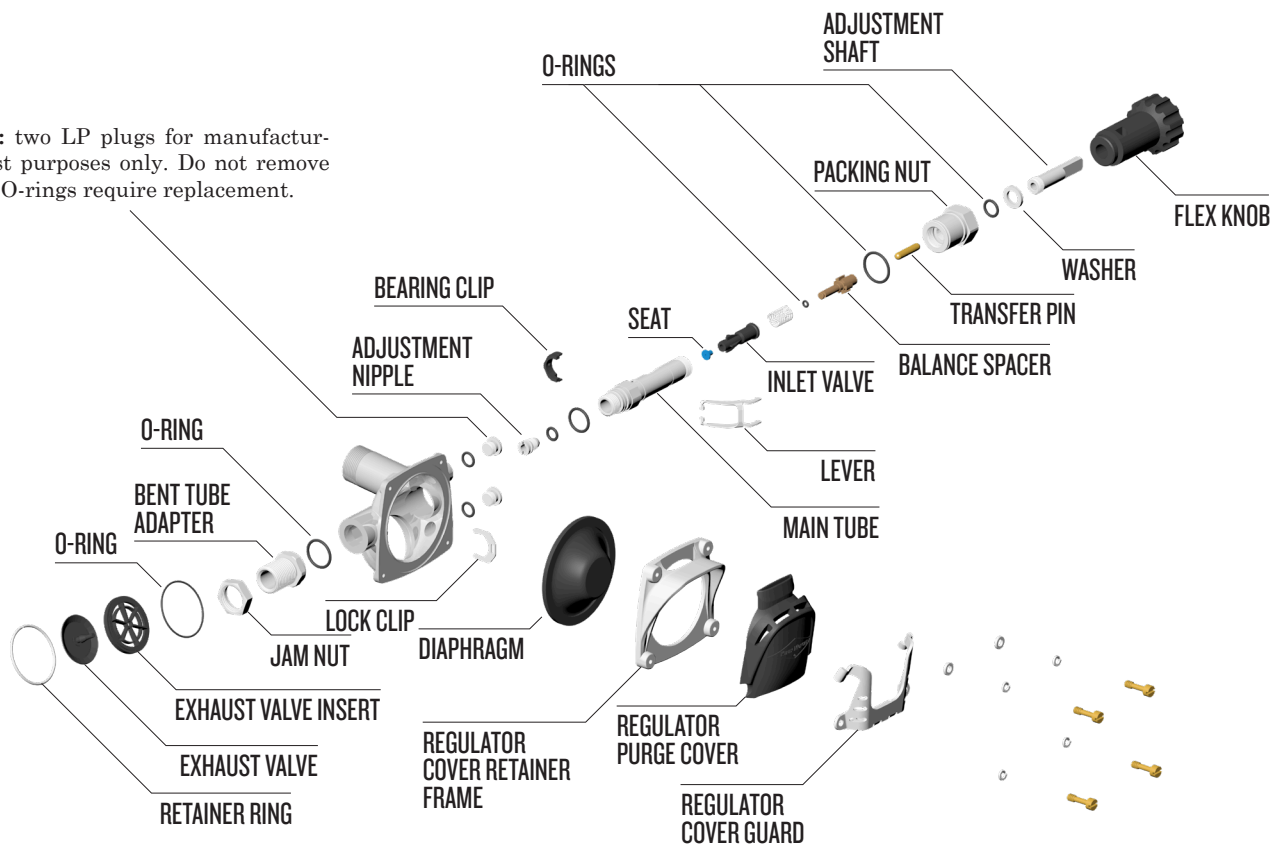

Exploded view of 455 Balanced regulator.

ment in very small increments and re-check after each adjustment. Usually $\frac{1}{16}$ turn at a time or less will suffice.

1) Remove the bent tube assembly, per "1.3.1 Removal of the Bent Tube Assembly" on page BNT-4.

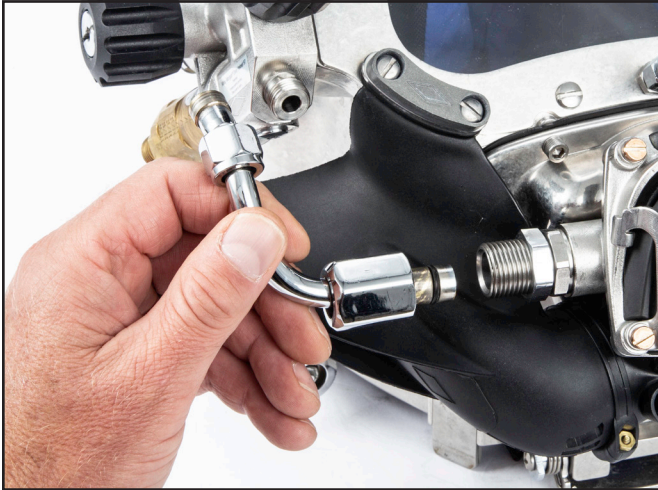

Remove the bent tube assembly.

2) Remove the bent tube adapter.



Remove the bent tube adapter.

3) Turn the adjustment knob all the way in (clockwise toward the regulator) then back out (counter clockwise) three full turns.

4) Insert a $\frac{1}{4}$ inch wide flat head screwdriver into the slot in the end of the adjustment nipple to make adjustments as necessary. Be sure to attach an L.P. gas supply and test the regulator between adjustments.



Helpful Hint

Turning the adjustment nipple in (clockwise) will increase lever play and increase the free range of the purge cover. Turning the adjustment nipple out (counterclockwise) decrease lever play and decreases the free range of the purge cover.



Turn the adjustment nipple $\frac{1}{16}$ of a turn at a time to adjust the performance of the regulator.

1.3 455 Balanced Regulator Removal from Helmet or BandMask

Tools required:

- Cutting Pliers
- $\frac{11}{16}$ inch Open End Wrench
- (2) $\frac{7}{8}$ inch Open End Wrench
- 1 $\frac{3}{8}$ inch socket or Regulator Mount Socket Wrench P/N 525-625 (Found in 525-620 Tool kit).
- $\frac{3}{8}$ inch Drive Extension with driver, minimum 3 inches in length
- $\frac{1}{4}$ inch Flat Blade Screwdriver

1) Remove the bent tube assembly, per "1.3.1 Removal of the Bent Tube Assembly" on page BNT-4.



Remove the bent tube assembly.

- 2) Remove nose block assembly, per "1.2.1 Nose Block Assembly Removal" on page FCPRT-6.
- 3) Remove the screws, anodes or kidney plates and whisker spacers from the whiskers.

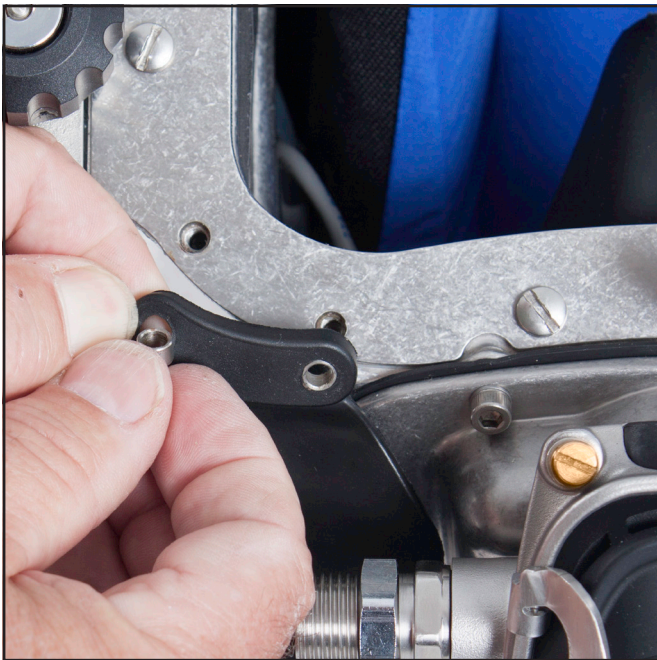

Be sure to remove and set aside the whisker spacers.

- 4) Release the Oral Nasal Mask from its secure fit around the Regulator Mounting nut.
- 5) Clear the mask away from the Regulator Mounting Nut and remove nut with sealing O-ring.
- 6) Cut the tie wrap that connects the quad valve

exhaust main body to the water dump tube on the helmet pod.

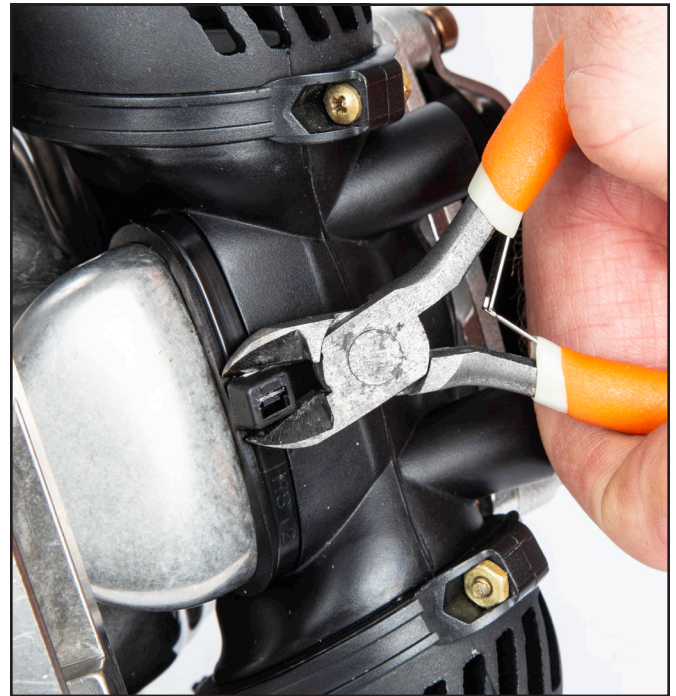

Cut the tie wrap that connects the quad valve exhaust main body to the water dump tube on the helmet pod.

- 7) Remove the regulator assembly from the helmet.



Remove the regulator from the helmet.

- 8) The center section of the exhaust flange on

the regulator body has a tie wrap holding it to the helmet. Remove the tie wrap then stretch the main exhaust body off the regulator exhaust flange.



Remove the tie wrap.



Separate the regulator from the Quad Valve™ exhaust whiskers.

1.4 455 Balanced Regulator Disassembly

1.4.1 Regulator Cover Retainer Assembly Disassembly

Tools required:

- ¼ inch Flat Blade Screwdriver

The 455 regulator cover retainer assembly includes the Cover Retainer Frame, Purge Cover, Cover Guard and its associated mounting hardware.

It is secured to the regulator body with four

stainless steel screws using a washer and lock washer configuration. The two lower screws can be changed to a bishop type pin which is standard when using the KM 97 water shroud.

The screws are captive and allow the technician to partially unscrew the four screws to release the cover assembly from the regulator body. The screws will remain with the assembly. It is unnecessary to completely unscrew the screws from the retainer frame.



NOTE

If the purge cover is in good condition there is no reason to remove it from the Regulator Cover Retainer Frame.

1) Remove the four screws from the cover retainer assembly completely **only to inspect the screws and verify all washers are present.**



Loosen the screws and washers on either side of the cover.

2) With the screws removed and the cover guard separated pull the purge cover out of the cover retainer.

3) Remove diaphragm and inspect. Check to determine if diaphragm rubber has separated from the metal disc. Hold the diaphragm to a bright white light, while pulling and stretching to reveal damage, deterioration, or holes. Diaphragms showing any indication of damage should be replaced. The diaphragm should always be replaced during scheduled annual overhauls



Remove the diaphragm and inspect it carefully. If it is torn or punctured it must be replaced.

1.4.2 Main Tube Disassembly

Tools required:

- ¼ inch Flat Blade Screwdriver
- ⅞ inch Open End Wrench
- 1½ inch Open End Wrench

1) Remove the bent tube assembly from the helmet, per "1.3.1 Removal of the Bent Tube Assembly" on page BNT-4.

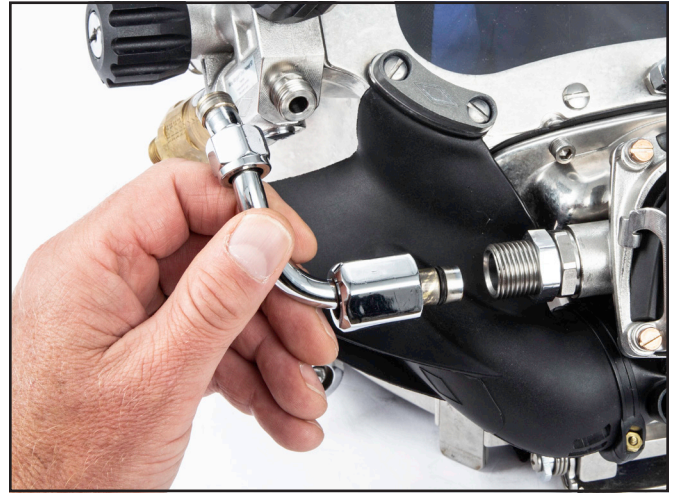

Remove the bent tube assembly.

2) Using a ⅞ inch wrench, remove the bent tube adapter and O-ring. Be careful not to lose the O-ring.



Remove the bent tube adapter and O-ring.

3) Loosen the four screws on both sides of the regulator cover.



Loosen the screws and washers on either side of the cover.



NOTE

These four screws should NOT be removed from the cover assembly. The cover assembly is designed to retain the screws to prevent loss. Unthread the screws only enough to allow the cover assembly to separate from the main body of the regulator to expose the interior parts.

4) Remove the cover assembly and diaphragm.



IMPORTANT

Inspect the diaphragm for holes or tears. If it is torn or punctured it must be replaced. Inspect the interior of the regulator for foreign matter and clean if necessary.



Remove the cover assembly.

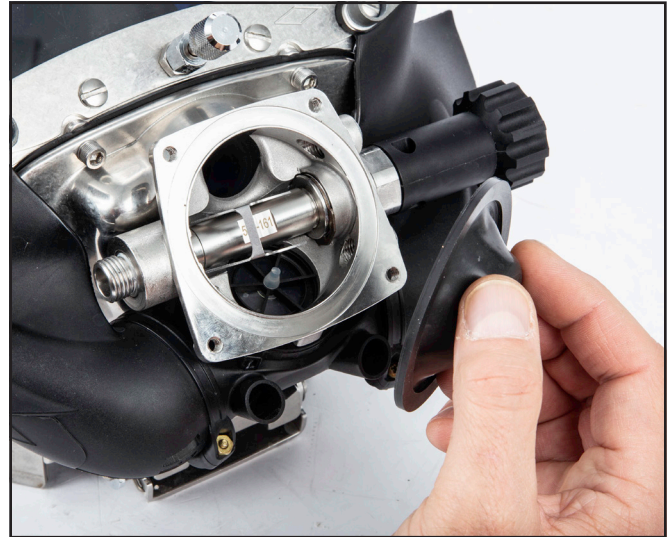

Remove the diaphragm and inspect it carefully. If it is torn or punctured it must be replaced.

5) Insert the tip of a flat blade screwdriver into the slot at the top of the lock clip and slide the clip away from the regulator main tube.

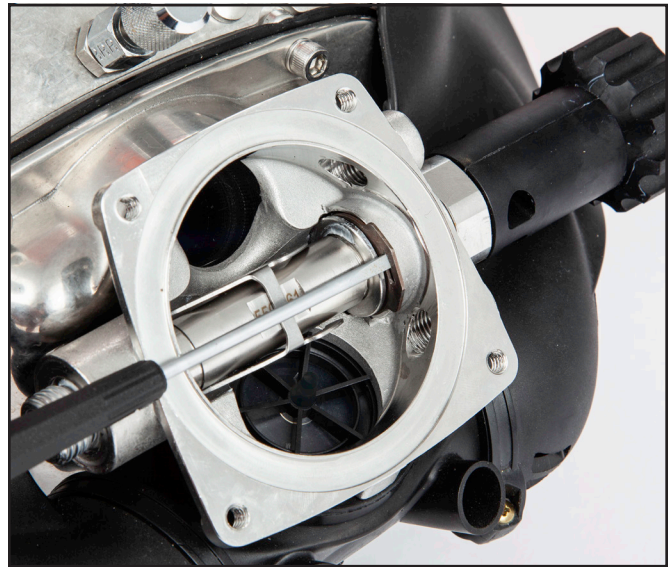

Carefully insert the tip of a flat blade screwdriver into the slot at the top of the lock clip to remove.

6) Using the $\frac{1}{16}$ " open end wrench, loosen the packing nut about one turn. Next, while fully depressing the lever arm, grasp the flex knob and pull it straight away from the regulator body.



NOTE

It may be necessary to use a soft hammer to break the main tube loose from the regulator body.

This will remove the main tube as a single, easy to handle unit.



When you pull the flex knob assembly out, the main tube and related parts will follow.

1.4.3 Flex Knob Disassembly

Tools required:

- Small Screwdriver or Wooden Dowel (Chopstick)
- Table Vise
- O-ring Pick

1) Unscrew the flex knob assembly from the main tube.



Unscrew the flex knob assembly from the main tube.

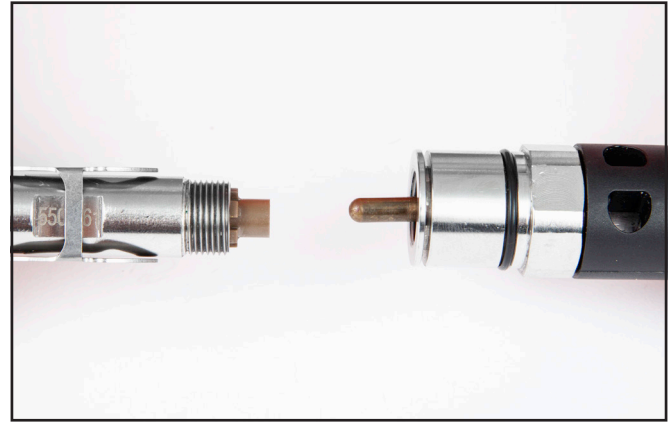

The transfer pin may fall from the end of the shaft. Be careful not to lose it.

2) Remove the O-ring from the flex knob assembly packing nut.

Inspect for signs of wear and replace if necessary. Otherwise, if it is in good condition, set it aside for cleaning and lubrication.



Remove the O-ring from the flex knob packing nut. You can use a credit card, toothpick, or any clean soft device that will not damage the O-ring or the nut.

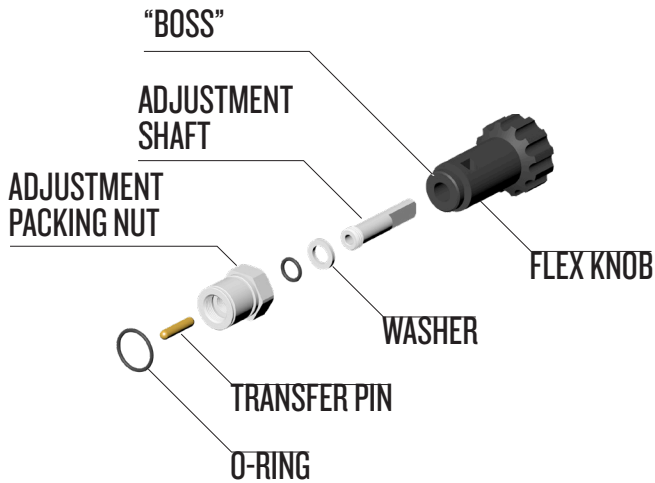

The adjustment shaft must be completely removed to allow the removal of the flex knob. **DO NOT ATTEMPT** to SEPARATE THE KNOB and PACKING NUT without **FIRST REMOVING** the ADJUSTMENT SHAFT.

3) Hold the packing nut while turning the flex knob clockwise until it stops.

 You will notice the internal adjustment shaft will travel outward AWAY from the packing nut.

4) Insert a small screwdriver into the outer end of the flex knob and push into the Flex Knob to dislodge the adjustment shaft from the assembly and remove.



The adjustment shaft must be completely removed to allow the separation of the flex knob and packing nut.

5) Grab the packing nut with one hand or vise, and the flex knob with the other and bend to separate the two parts.



With the shaft out, the flex knob can be separated from the packing nut.

6) Using an O-ring pick, carefully remove the shaft bearing washer and O-ring.



Remove the O-ring from the main tube.



Using an O-ring pick, carefully remove the bearing washer and adjustment shaft O-ring.

2) Remove the bearing clip.



Remove the bearing clip.

1.4.4 Main Tube Components Disassembly

Tools required:

- Flat Blade Screwdriver
- Wooden Dowel (Chopstick)

1) Remove the O-ring from the exterior of the main tube.

3) Remove the lever by slightly pulling one leg out from the slot on the main tube, followed by the second leg.

4) Slide the balance spacer, spring, and inlet valve assembly out from the main tube and separate.



NOTE

Check the condition of this O-ring very carefully. If there are any signs of damage, it must be replaced. Pay close attention to this seal!

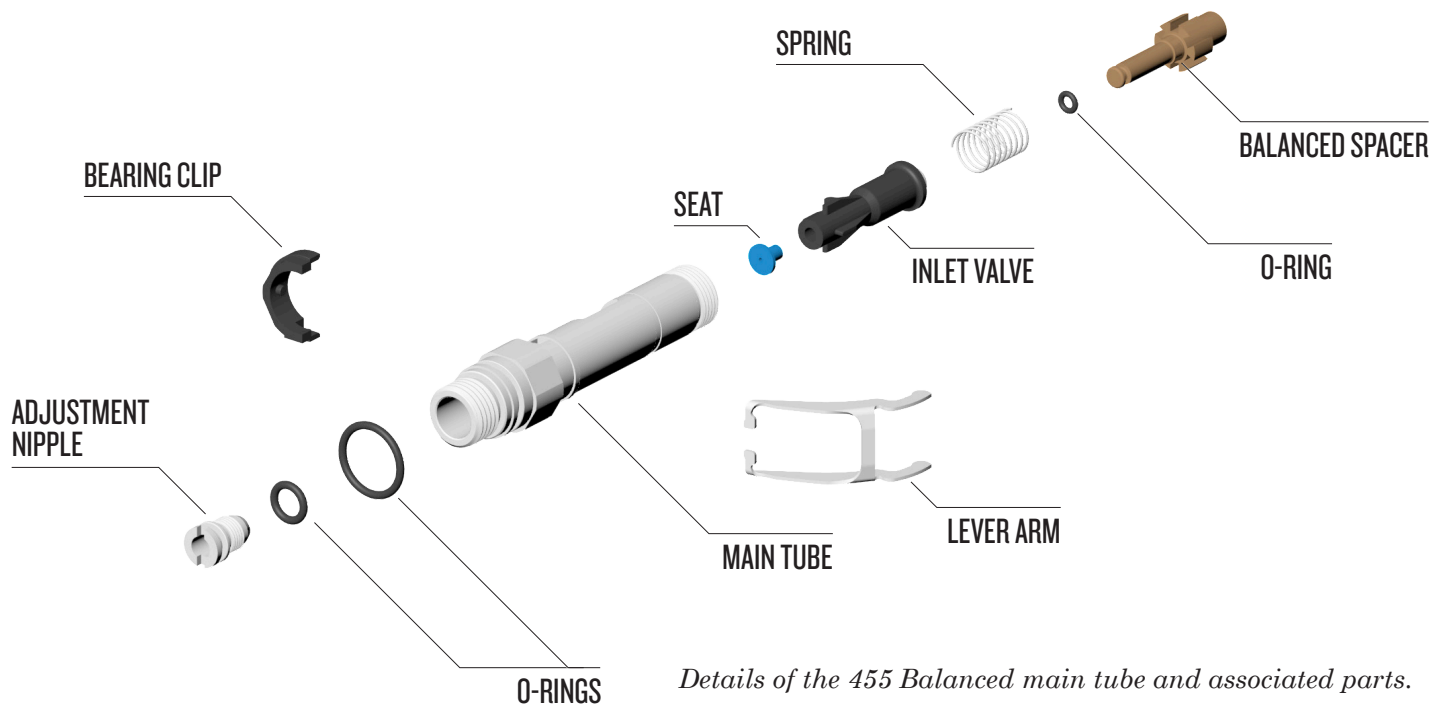

Remove the balance spacer, spring and inlet valve assembly from the main tube.



Unscrew the adjustment nipple all the way out to free the threads from the main tube.

5) Using a flat blade screwdriver, unscrew the adjustment nipple all the way out to free the threads from the main tube.

6) Use the wooden dowel rod (chopstick) to push it free.



NOTE

Carefully check the inlet nipple O-ring for damage, even small cuts may cause leaking.

Inspect all parts for signs of wear or damage and replace if necessary.



Use the wooden dowel rod to push it free.

1.4.5 Regulator Body and Exhaust Disassembly

Tools required:

- Small Flat Blade Screwdriver
- 5/32 inch Allen Wrench

1) Remove the exhaust valve insert retainer ring from the regulator body.



Use a small flat blade screwdriver to remove the exhaust valve insert retainer ring from the regulator body.

2) Remove the exhaust valve assembly and its sealing O-ring from the regulator body and separate the exhaust valve from the insert.



Remove the exhaust valve insert assembly.

3) Inspect all parts for signs of wear or damage and replace if necessary.

4) Inspect the interior of the regulator for foreign matter and clean if necessary.

If performing an annual overhaul

5) Remove the two port plugs and their O-rings and replace the O-rings.



Remove the two port plugs and their O-rings and replace.

bricant and would like to acknowledge Krytox®, Fluorolube® and Tribolube® as equivalent oxygen compatible lubricants.

1.5.1 Regulator Body and Exhaust Reassembly

Tools required:

- Flat Blade Screwdriver

1) Inspect the interior of the regulator body and make sure that it is clean and there is no foreign matter.

1.5 455 Balanced Regulator Reassembly

When reassembling the 455 Balanced regulator use only an oxygen compatible lubricant. We currently use the reference to lubricate using Christo-Lube® or equivalent oxygen compatible lu-

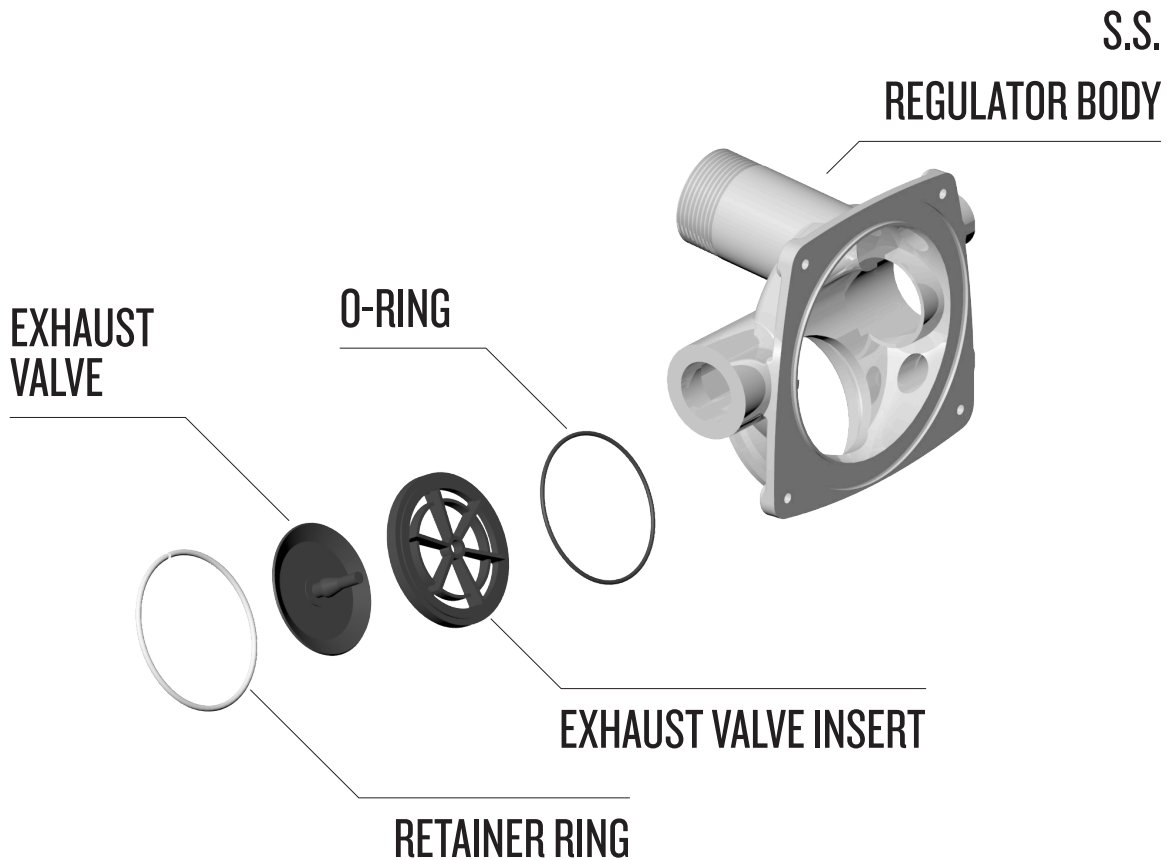

455 Balanced exhaust valve mechanism.

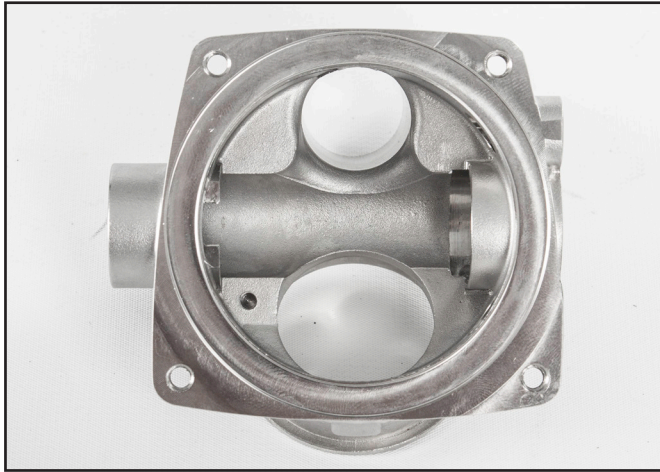

The regulator body must be clean and free of foreign matter.

2) Install the O-ring for the exhaust valve insert, into the regulator body.

3) Install the new exhaust valve into the exhaust valve insert.



NOTE

Use care to ensure the valve is mated to the proper side of the exhaust valve insert. The exhaust valve installs on the side that has the ring support.

⚠ WARNING

If the exhaust valves are installed backwards, they will leak. This may result in serious injury or death.

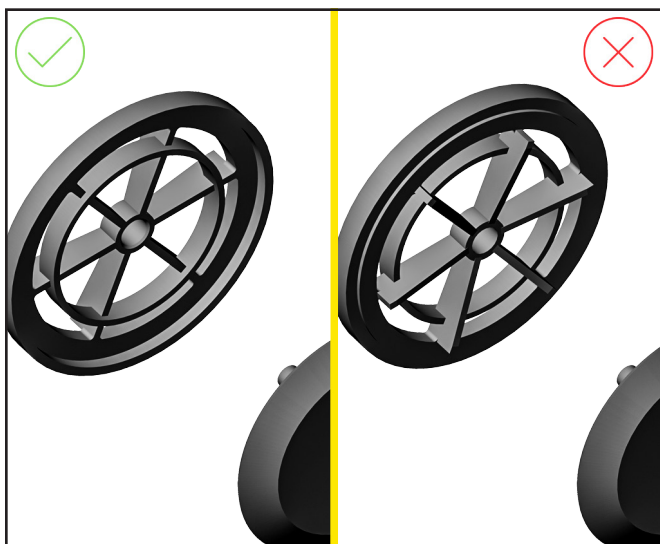

Install the new exhaust valve (if needed) into the insert. Use care to ensure the valve is mated to the proper side of the exhaust insert.

4) Place the exhaust valve insert with exhaust valve installed on top of the O-ring.



NOTE

The exhaust valve insert must be oriented so that it seals against the O-ring and the exhaust valve will mate properly with the insert.



Install the O-ring and valve insert.

5) Install the retainer clip.



NOTE

A flat blade screwdriver can be used to push the retainer clip into the groove. The clip should lock into place. Make sure it is pressed into the groove completely. This is extremely important to prevent the exhaust components from becoming dislodged. The ends of the ring should have a gap between them.



Install the retainer clip.

6) Cut off any excess tail from the exhaust valve that protrudes into the regulator body.

7) To test to see if the insert is installed properly by trying to spin the insert. It should be difficult, or not able to turn. You should not be able to dis-

lodge the insert by hand. Also check to make certain the exhaust valve will not get caught on the free end of the retainer clip which will cause the valve to flap open.



To test to see if the insert is installed properly, try to spin the insert. It should be difficult, or not able to turn.

If performing an annual overhaul

8) Install O-rings onto port plugs and install into regulator body.



Install O-rings onto port plugs and install into regulator body.

1.5.2 Flex Knob Reassembly



**How To: Install
455 Flex Knob**

<https://www.youtube.com/watch?v=-LXwsBR228k>

Tools required:

- Christo-Lube® or Equivalent
- Table Vise
- A Rag or Cloth

1) Lubricate the O-ring and shaft bearing washer then place the O-ring into the adjustment packing nut followed by the shaft bearing washer. Press the washer down with a finger to lock the components into the adjustment packing nut.

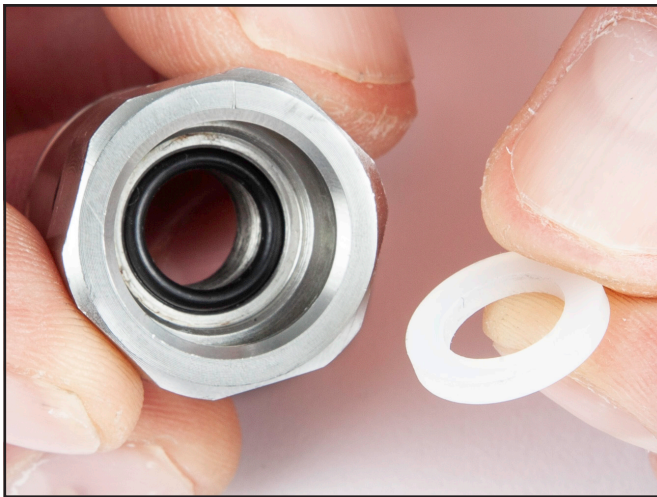

Place the O-ring into the adjustment packing nut followed by the shaft bearing washer.

2) Lightly lubricate the groove in the end of the flex knob with Christo-Lube® or equivalent oxygen compatible lubricant.



Lightly lubricate the groove in the end of the flex knob.

3) Place the packing nut into a vise and insert the flex knob into the adjustment packing nut at an angle, twisting the knob while pushing down into the adjustment packing nut.



NOTE

Use of a rounded tool or the shaft of a screwdriver to push the flex knob into the adjustment packing nut can be useful.



Place the packing nut into a vise and insert the flex knob into the adjustment packing nut at an angle.

4) Lubricate the threads of the adjustment shaft with Christo-Lube® or equivalent and insert into the flex knob.



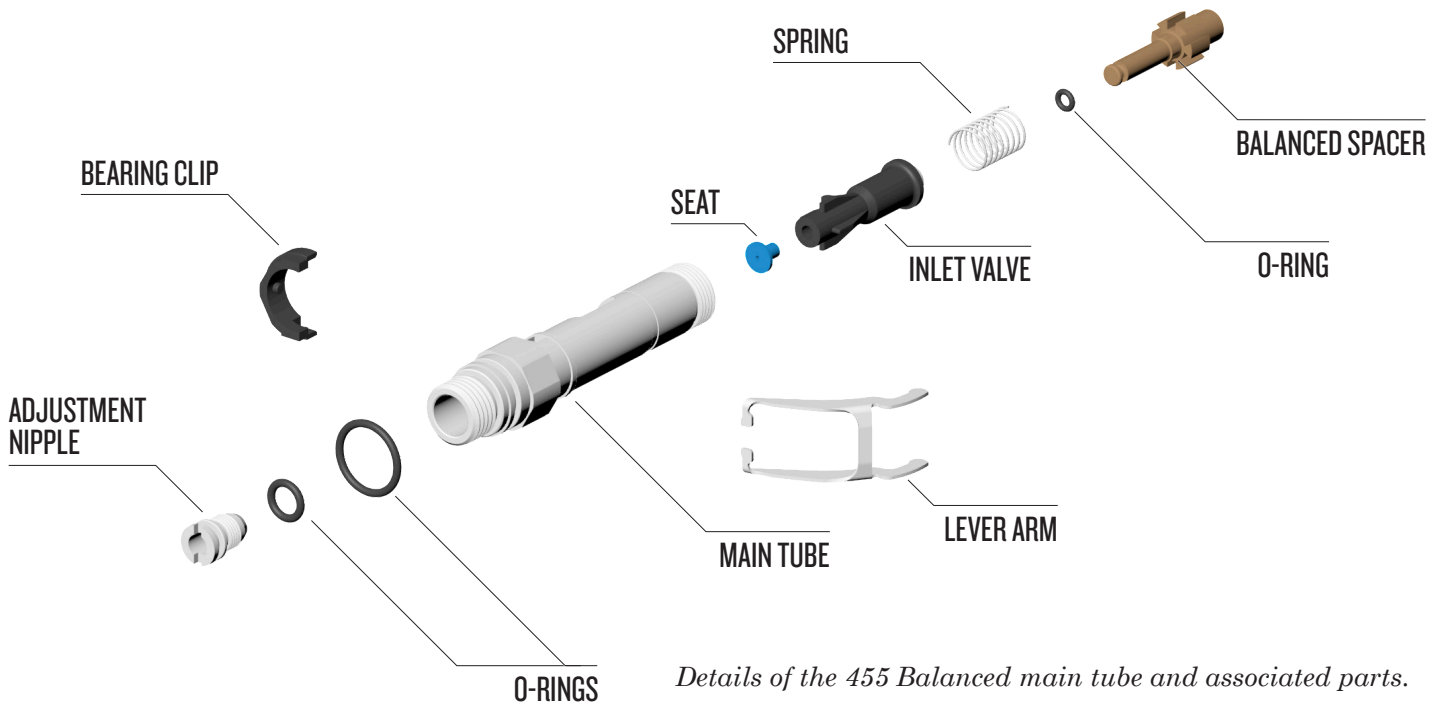

Lubricate the threads of the adjustment shaft with Christo-Lube® or equivalent and insert into the flex knob.

5) Push on the adjustment shaft's end while turning the flex knob counterclockwise to engage threads. Continue turning the flex knob counterclockwise until the flex knob stops.



Push in on the adjustment shaft while turning the flex knob counterclockwise to engage threads

6) Lubricate and install the external O-ring onto the adjustment packing nut.

1.5.3 Main Tube Components Reassembly

Tools required:

- Christo-Lube® or Equivalent
- Small Flat Blade Screwdriver

Replace any parts if damage is present or suspected. If a normal overhaul is being conducted replace all soft goods. Lubricate O-rings and moving parts with a light coating of Christo-Lube®, Krytox®, Fluorolube®, or Tribolube® are also acceptable lubricants.

1) Install the O-ring onto the main tube.



Install the O-ring onto the main tube.

2) Install the O-ring onto the balance spacer and lubricate with Christo-Lube® or equivalent and set aside.

⚠ WARNING

DO NOT OVER LUBRICATE THE O-RINGS ON THE BALANCE SPACER. Excess lubrication could possibly collect at the end of this part and block the critical air balancing hole.

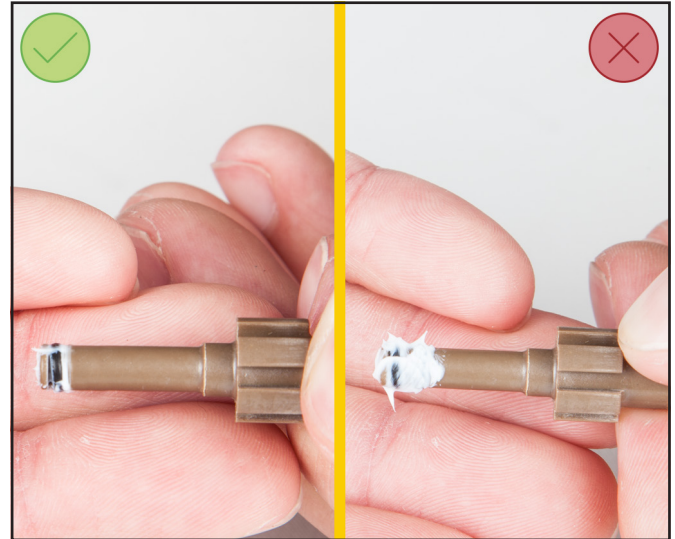

Do not over lubricate the O-ring on the balance spacer.

3) Spread the arms of the lever just enough to install it onto the main tube. The cross member on the lever should rest on the flat spot of the main tube where you can read the part number 550-161.



NOTE

Study the features of the inlet valve assembly. There are four “wings” towards one end of the assembly and a bore that creates the balance chamber on the opposite end.

The wings that align with the lever arm are the two that have an additional wall for the lever arm to bear on. The valve assembly should be inserted into the main tube with these walls toward the bottom of the regulator tube.

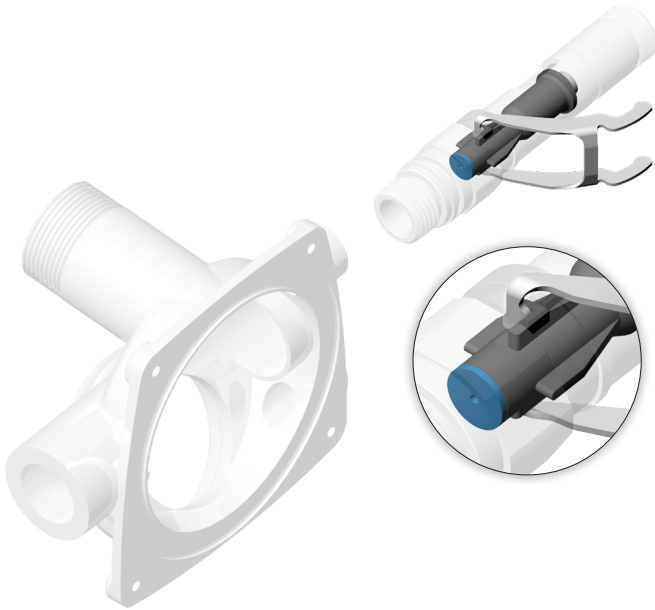

Close-up detail of the inlet valve.

4) With the spring in place, using the balance spacer with the O-ring installed, insert the balance spacer into the stainless steel tube of the inlet valve, stop at the O-ring.



Using the balance spacer with the O-ring installed, insert the O-ring into the open end of the inlet valve and stop.

5) Properly align the wings found on the inlet body and insert the inlet valve into the main tube, as previously noted.



If this is done properly, the lever should lift up when pressure is applied. If it does not, the valve has not been inserted correctly.

NOTE



Align and insert the inlet valve into the main tube.

6) While holding the inlet valve in position, pinch each arm of the lever and slowly remove the balance spacer.

The inlet valve should remain in place while pinching the lever arms. If it comes out, repeat the process until the valve stays in place.

7) Install the spring and balance spacer as a unit into the main tube.



Confirm the balance spacer is properly aligned inside the main tube by pushing in on the end of the spacer, to see that the lever arm moves when pressure is applied.

NOTE



Install the spring and balance spacer with O-ring into the main tube.

8) Lightly lubricate the ends of the transfer pin and install into the end of the balanced spacer.



Lightly lubricate the ends of the transfer pin and install into the end of the balance spacer.

9) Confirm the flex knob is turned all the way out (counterclockwise) and can not be turned out further.

10) Thread the flex knob assembly onto the main tube until it stops.

Handle and thread the flex knob by the adjustment packing nut **NOT THE FLEX KNOB**. The flex knob should be assembled with the adjustment knob turned **all the way out** (counterclockwise).



Thread the flex knob assembly onto the main tube until it stops.

11) Install the bearing clip onto the outside of the main tube.

FITTING THE BEARING CLIP

The multifaceted side of the bearing clip faces the hex side of the main tube. The rounded side faces toward the adjustment knob assembly. There is a locating pin on the clip that must engage the correct hole on the main tube. There are also small recesses on either side that the legs of the lever arm fit into.



NOTE

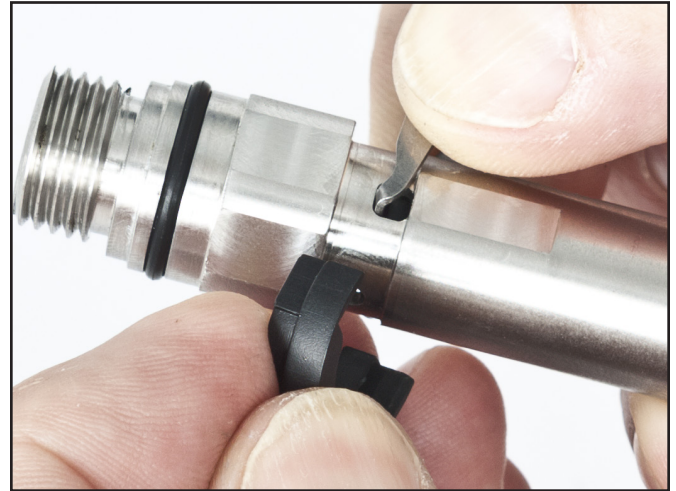

Install the bearing clip onto the outside of the main tube.

12) Install the O-ring on the adjustment nipple. Lubricate with Christo-Lube® or equivalent lubricant.



Install the O-ring on the inlet nipple.

13) Insert the adjustment nipple into the main tube.



Thread the adjustment nipple into the main tube.

14) Using a flat blade screwdriver, thread the nipple into the tube slowly as soon as you see any movement and/or drop of the lever, stop threading the nipple in.



Using a flat blade screwdriver, thread the nipple into the tube slowly

⚠ CAUTION

If the adjustment nipple is screwed into the main tube too far or until it cannot go further, damage to the valve seat is possible.

The adjustment nipple will stop at ten full turns. Damage to the seat may cause it to wear out faster than normal and, in extreme cases, could cause the adjustable nipple to seal improperly on the seat resulting in slight free flow.

1.5.4 Installing the Main Tube into the Regulator Body



NOTE

Regulator should always be tested for proper adjustment once the Main Tube is installed.

Tools required:

- Torque Wrench
7/8 inch & 15/16 inch Open End Attachments
- Christo-Lube® or equivalent oxygen compatible lubricant

1) Confirm the main tube O-ring has been installed and is lubricated.

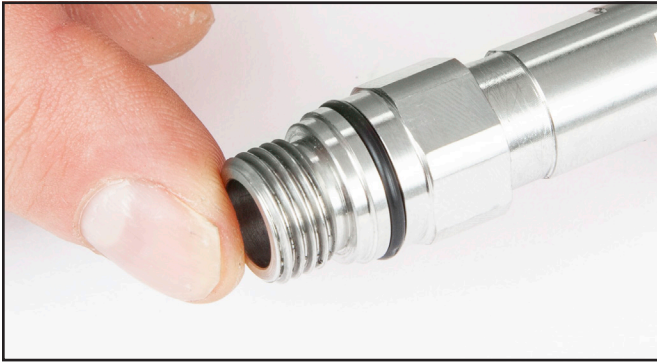

Confirm the main tube O-ring has been installed and is lubricated.

2) Lubricate the internal area of the regulator where the main tube O-ring will inset. This is important to help prevent this O-ring from possibly getting cut when it is installed.

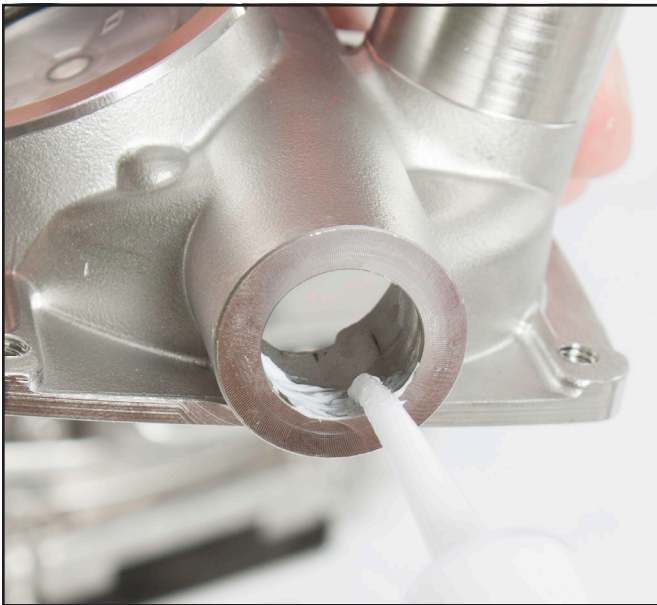

Lubricate the internal area of the regulator with Christo-Lube® or equivalent.

3) Unscrew flex knob assembly until three to four threads are showing.

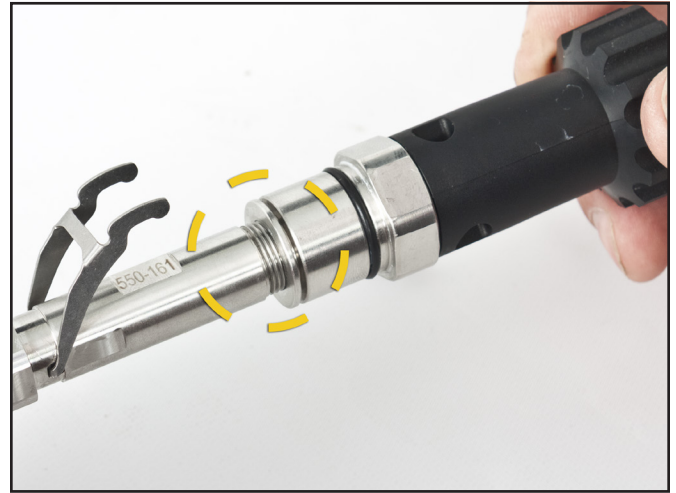

When installing the main tube into the regulator body it is critical to leave three plus threads exposed on the main tube.

4) Depress the lever arm down and carefully install the main tube assembly into the regulator body with the lever arm facing toward you so it is visible.

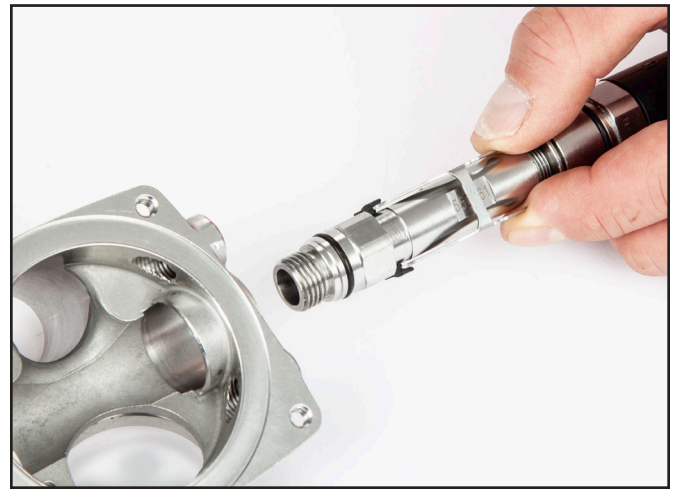

Depress the lever arm down and carefully install the main tube assembly into the regulator body.

Push the main tube until the threaded end of this assembly comes completely through to the opposite side of the regulator body. Make sure the HEX flat area on the main tube aligns to the mating HEX in the regulator body.



Make sure the nut on the adjustment knob is not tight against the regulator body.

NOTE

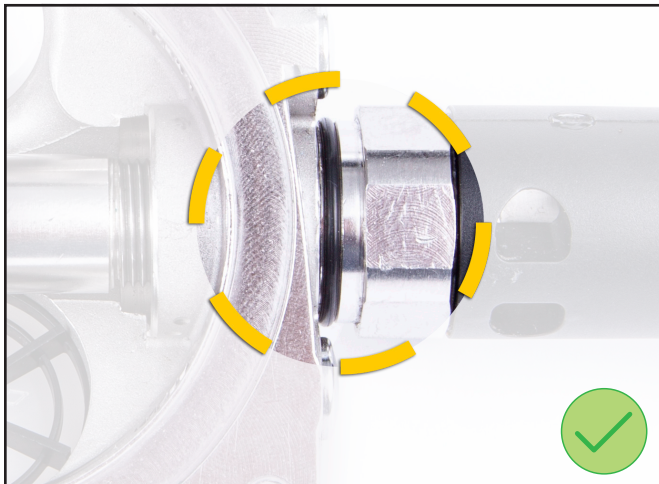

Install the O-ring in the bent tube adapter.

SECOND

6) Tighten the packing nut at the flex knob to the torque specifications. See "Torque Specs" module.

7) Turn in on the flex knob until an audible click is heard then out three full turns. This is typically very close to optimum adjustment.

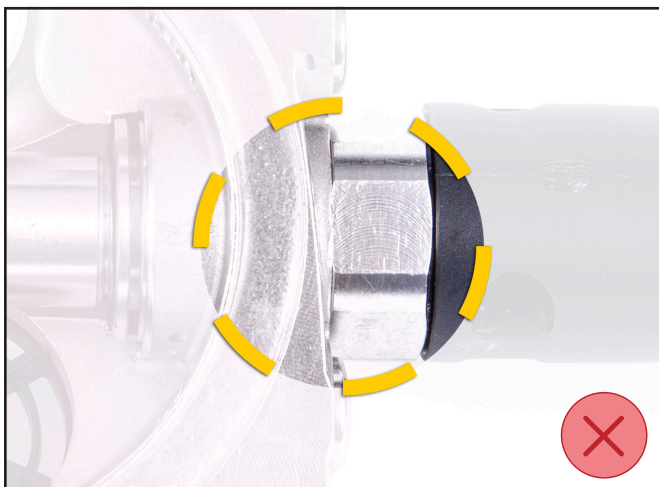

It is important to do steps 5) and 6) in this sequence.

FIRST

5) Install the O-ring onto the bent tube adapter and tighten adapter to the torque specifications. See "Torque Specs" module.

A small gap should be visible between the regulator body and the Adjustment Packing Nut. If no gap is observed remove bent tube adapter.



The hex nut will have to be unscrewed a little more from the main tube to allow for correct installation. Reinstall the adapter and re torque.



Turn in on the flex knob until an audible click is heard then out three full turns.

8) Install the lock clip on the main tube.



Install the lock clip on the main tube.

9) Remove the bent tube adapter to allow pressure adjustment. With the bent tube adapter removed, secure a standard low pressure SCUBA hose to the main tube (recommend testing pressure is 130—150 PSI) Pressurize and check lever play for ¼". After the pressure adjustment, remove the supply hose and reinstall the bent tube adapter and torque. See "Torque Specs" module.

10) Reinstall the diaphragm and cover assembly. Tighten the screws to the torque specifications. See "Torque Specs" module.



Regulator should always be tested for proper adjustment once the Main Tube is installed.



Install the diaphragm, cover assembly and cover retaining screws and torque.

11) If necessary, adjust the regulator per "1.2.2 Adjusting the 455 Balanced Regulator" on page 455BAL-3.

1.5.5 Regulator Cover Retainer Assembly Reassembly

Tools required:

- ¼ inch Flat Blade Attachment on Torque Screwdriver

The 455 regulator cover retainer assembly includes the cover retainer frame, purge cover, cover guard and it associated mounting hardware.

It is secured to the regulator body with four stainless steel screws using a washer and lock washer configuration. The two lower screws can

be changed to a bishop type pin which is standard when using the water shroud and KM Diamond.

All of the screws are not threaded all the way down and allow the technician to partially unscrew the four screws to release the cover assembly. The screws will remain with the assembly and it is unnecessary to completely unscrew the screws from the retainer frame.

If Regulator Cover Retainer Assembly has been taken apart

1) Insert the purge cover into the regulator retainer frame. Use one corner of the purge cover to begin the insertion into the slot found on the retainer frame. Force the purge cover into the slot until it can go no further and the two parts are mated.



Insert the purge cover into the regulator retainer frame.

- 2) Push the body of the purge cover through the large opening on the retainer frame.
- 3) Align the outer edge of the purge cover so it captures the upraised edge on the retainer frame.



- 4) Place the cover guard onto the retainer frame.
- 5) Install lock washer on all four screws first, followed by the washer onto the screws and screw into retainer cover.

Diaphragm Inspection

- 6) Check to determine if diaphragm rubber has separated from the metal disc. Hold the diaphragm to a bright white light, while pulling and stretching to reveal damage, deterioration, or holes. Diaphragms showing any indication of damage should be replaced. The diaphragm should always be replaced during scheduled annual overhauls.
- 7) Place the diaphragm onto the regulator body. Ensure it is correctly fitted into the recessed edge.



Place the diaphragm onto the regulator body.

8) Fit the regulator cover retainer assembly onto the regulator body.



Fit the regulator cover retainer assembly onto the regulator body.

9) Torque the screws evenly. See "Torque Specs" module.



Torque the screws evenly.

1.6 Installing the 455 Balanced Regulator onto the Helmet or BandMask

Tools required:

- Torque Wrench
1¹/₁₆, 7⁸/₈ inch Open End Attachments
- 3⁸/₈ inch Drive Extension—Minimum 3 Inches in Length
- 1 3⁸/₈ inch Socket or Regulator Mount Nut, P/N 525-625 (in Tool Kit included with Helmet)
- 7⁸/₈ inch Open End Wrench
- Torque Screwdriver
1⁴/₄ inch Flat Blade Attachment on Torque Screwdriver
- Christo-Lube® or equivalent oxygen compatible lubricant

1) Install the main exhaust body (with exhaust whiskers attached) onto the exhaust flange of the regulator body.



Install the main exhaust body onto the exhaust flange of the regulator body.

2) Install the tie wrap on the center section of the exhaust main body and tighten. Remove excess tie wrap.



Install the tie wrap on the regulator.



Remove excess tie wrap.

Steps 3) and 4) apply to the QUAD valve exhaust system

3) Pre-install a tie wrap onto the Quad Valve exhaust main body. This will make installation much easier and ensure a good seal.

4) Insert the open tube on the exhaust main body onto the tube of the helmet pod (stainless steel) or the water dump adapter cover (KM 37 & SL 17C), while at the same time aligning and inserting the threaded mounting tube of the regulator, into the mounting hole on the pod or helmet shell.



Insert the tube on the exhaust main body onto the tube of the helmet pod.

5) Secure and seal with a tie wrap. Remove excess tie wrap tail.



Secure and seal with a tie wrap.

6) Inspect the regulator mount nut for contaminants and damage. Use a tooth brush to clean threads as needed. Lightly lubricate the regulator mounting tube threads and the sealing O-ring with Christo-Lube®.



7) Install the sealing O-ring, then thread the regulator mount nut onto the regulator, finger tight ONLY.



Install the O-ring that mounts on the regulator tube inside the helmet.

8) Install the regulator mount nut. **DO NOT FULLY TIGHTEN THE NUT AT THIS TIME.**



*Install the regulator mount nut. **DO NOT FULLY TIGHTEN THE NUT AT THIS TIME.***

9) Install the bent tube per "1.3.3 Installation of the Bent Tube Assembly" on page BNT-4.

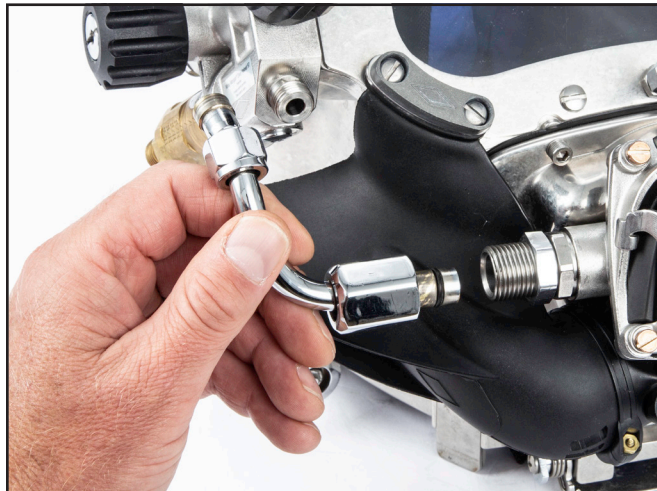

Install the bent tube assembly.

10) Use a torque wrench inside the helmet with a 1 3/8 inch socket or KMDSI regulator mount tool P/N 525-625 and extension to torque the regulator mount nut.

See "Torque Specs" module to confirm correct torque.



For stainless steel helmets ONLY:

Place a small amount of Loctite® 248 onto the last two or three threads at the end (end opposite the screw head) of each of whisker screws.

11) Attach the whisker to each side of the face port retainer using the spacers, zinc anodes or kidney plates and screws.

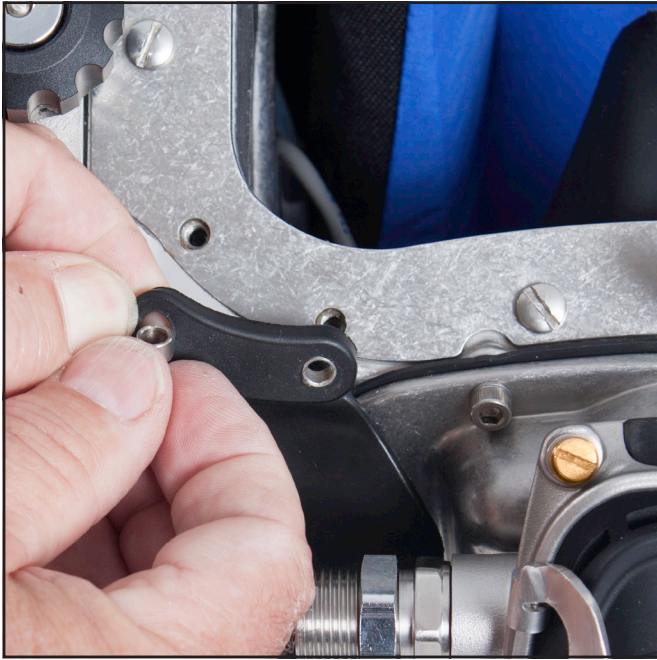

Attach the whisker to each side of the face port retainer using the spacers, zinc anodes or kidney plates and screws.

12) Using a torque screwdriver, carefully torque these screws to the correct torque for the helmet shell. See "Torque Specs" module.

13) Install the oral nasal mask per "1.1.3 Oral Nasal Mask Replacement" on page ON-2.

14) Install the nose block device per "1.2.2 Nose Block Device Replacement" on page FCPRT-6.